

Article number: 204060M863A3S

Description: E+G levelling foot
GN 40-60-M8-63-A3-S

Note: S Without nut, External hexagon at the bottom

Measures

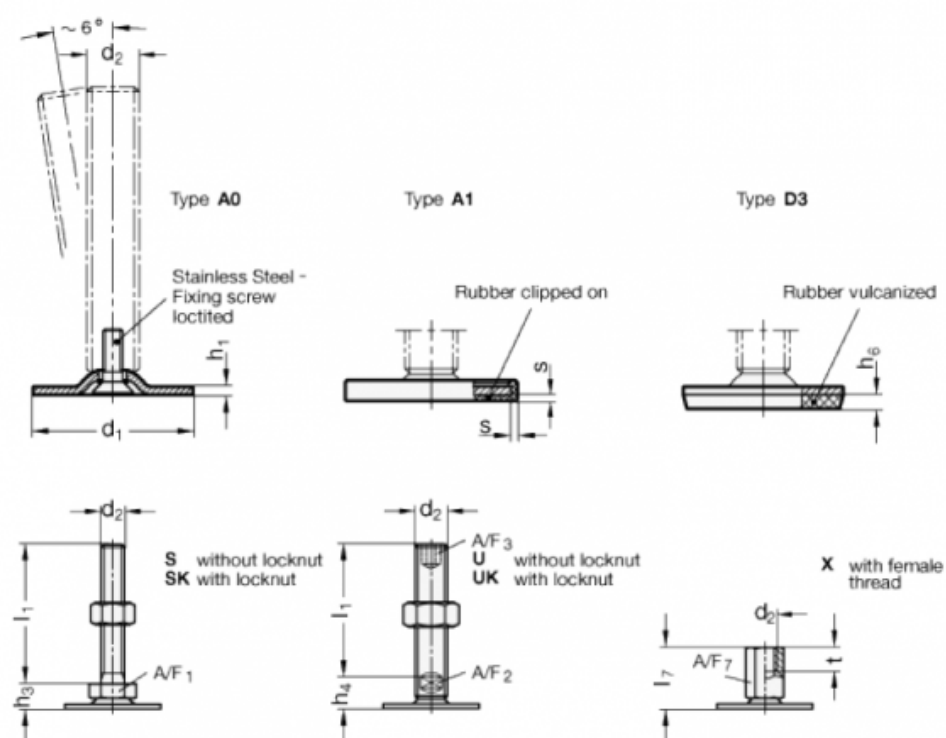

A/F1	= 17
d1	= 60
d2	= M8
h1	= 2.5
h3	= 11
h6	= 4.5
l1	= 63
s	=